

AlGaInP Visible Laser Diode

ADL-63054SL

DATE : 2006/7/31 Ver 2.0

★635nm 5mW 50°C Reliable Operation

• Features

1. Small size
2. High monitor current
3. High temperature operation

• Applications

1. High precision measuring instruments
2. High precision industrial laser markers
3. Survey and engineering instruments

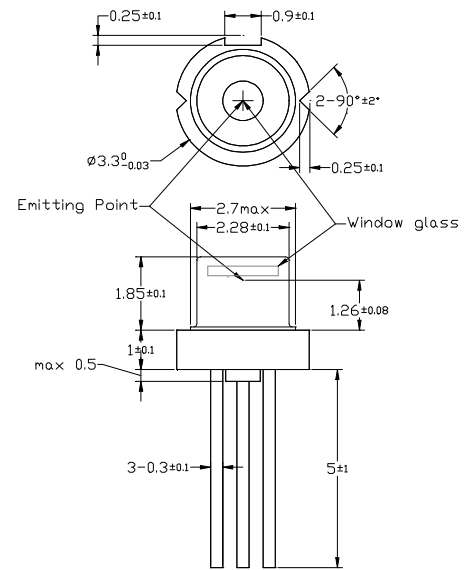

• Absolute maximum ratings

Parameter	Symbol	Condition	Rating	Unit
Light output power	P _O	CW	7	mW
Reverse voltage (LD)	V _{RL}	-	2	V
Reverse voltage (PD)	V _{RD}	-	30	V
Forward current (PD)	I _{FD}	-	10	mA
Case temperature	T _C	-	-10~+50	°C
Storage temperature	T _S	-	-40~+85	°C

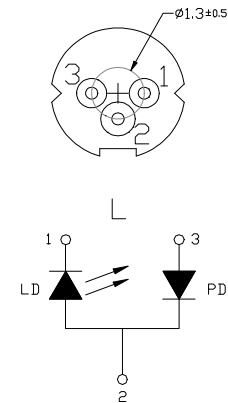

• Electrical and optical characteristics (T_c=25 °C)

Parameter	Symbol	Min.	Typ.	Max.	Unit	Conditions
Peak wavelength	λ	630	635	640	nm	P _o =5mW
Threshold current	I _{th}	-	24	30	mA	
Operating current	I _{op}	-	33	40	mA	P _o =5mW
Operating voltage	V _{op}	-	2.2	2.5	V	P _o =5mW
Differential efficiency	η	0.4	0.6	0.8	mW/mA	P _o =3-5mW
Monitor current	I _m	0.1	0.15	0.3	mA	P _o =5mW, V _{RD} =5V
Parallel divergence angle	$\theta_{ }$	6	7.5	11	deg	
Perpendicular divergence angle	θ_{\perp}	30	33	40	deg	
Parallel FFP deviation angle	$\Delta\theta_{ }$	-2	0	+2	deg	P _o =5mW
Perpendicular FFP deviation angle	$\Delta\theta_{\perp}$	-2	0	+2	deg	
Emission point accuracy	$\Delta x \Delta y \Delta z$	-60	0	+60	um	

• Precautions

- * Do not operate the device above maximum ratings. Doing so may cause unexpected and permanent damage to the device.
- * Take precautions to avoid electrostatic discharge and/or momentary power spikes. A change in the characteristics of the laser or premature failure may result.
- * Proper heat sinking of the device assures stability and lifetime. Always ensure that maximum operating temperatures are not exceeded.
- * Observing visible or invisible laser beams with the human eye directly, or indirectly, can cause permanent damage. Use a camera to observe the laser.
- * No laser device should be used in any application or situation where life or property is at risk in event of device failure.
- * Specifications are subject to change without notice. Ensure that you have the latest specification by contacting us prior to purchase or use of the product.

* For reference only. Contents above are subject to change without notice.

Arima
LASERS

AlGaInP Visible Laser Diode

ADL-63054SL

DATE : 2006/7/31 Ver 2.0

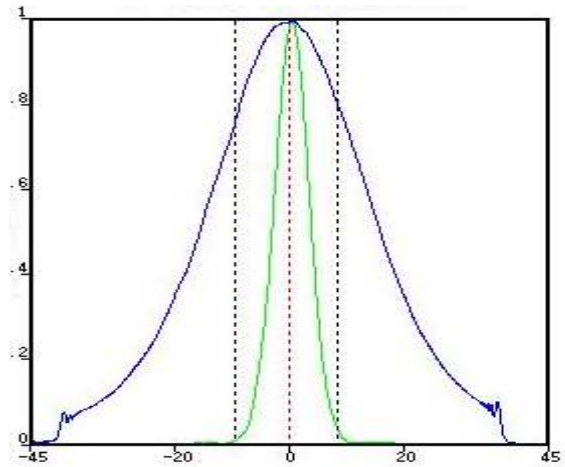
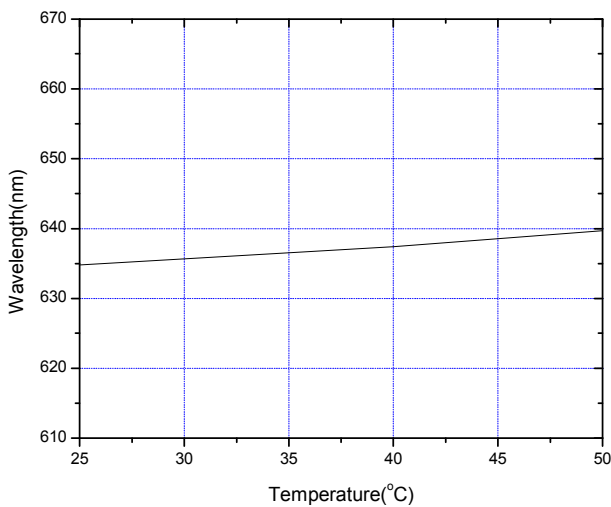
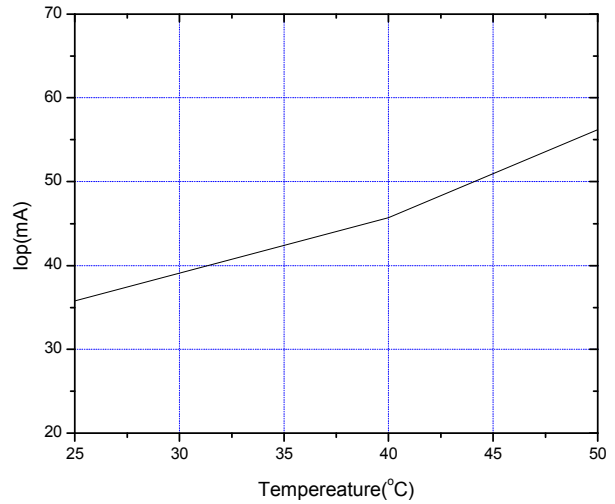
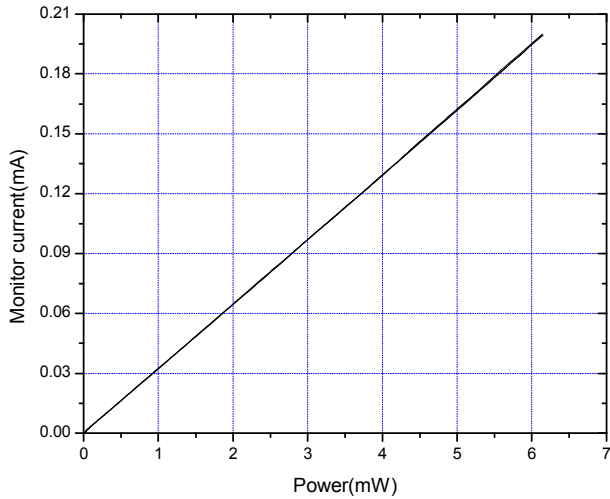
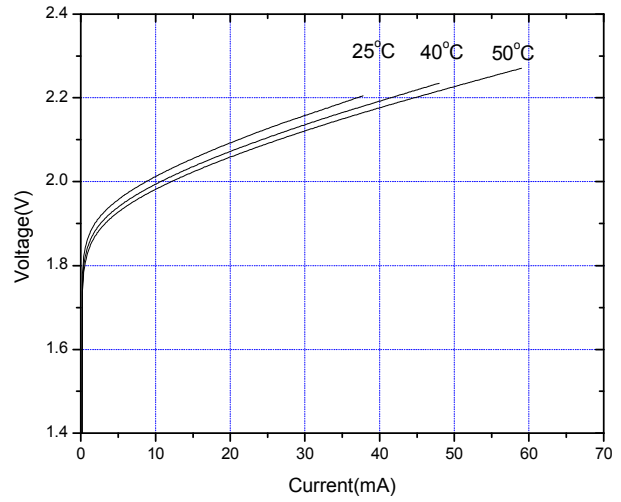
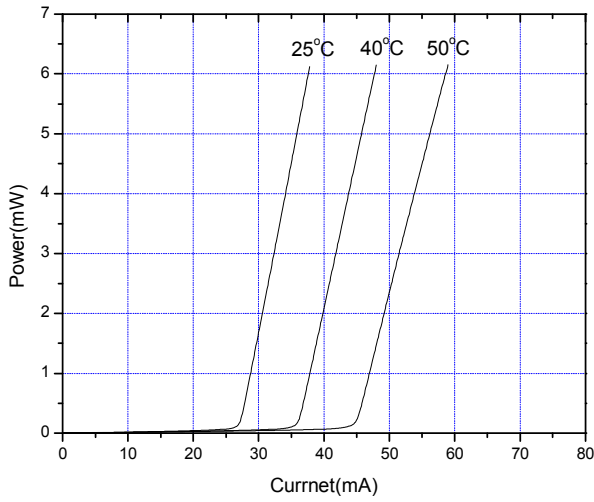

* For reference only. Contents above are subject to change without notice.